

PORTAS SECCIONADAS

 **Catalogo Portas** Modelos Industrial

2013 v2

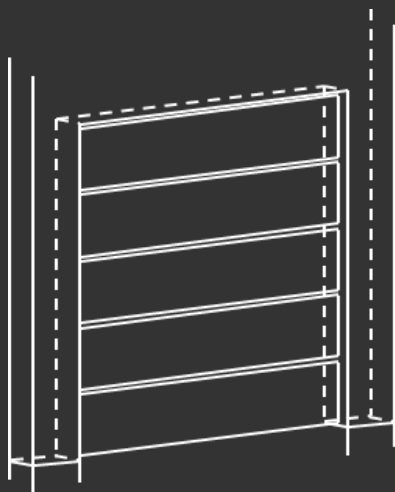

OPERTAC 2013 - info@opertac.com



SECTOR INDUSTRIAL...

Características da porta seccionada modelo IND:

- > Painel com 40mm, enchimento com poliuretano sem C.F.C.;
- > Painel com sistema anti-esmagamento de dedos;
- > Calhas galvanizadas com 1,5mm;
- > Sistema de anti-rutura de molas, DIN EN 12804;
- > Acessórios lacados em RAL 9010;
- > Vedante inferior e superior em EPDM;
- > Trinco interior;
- > Medidas standard / por medida;
- > Cavaletes largos metálicos;
- > Reforços;
- > Sistema mecânico reforçado;
- > Sistema de segurança Pára-quedas;
- > Certificação CE (EN13241-1:2003).

**Cores Standard disponíveis:
Textura VETEADO**

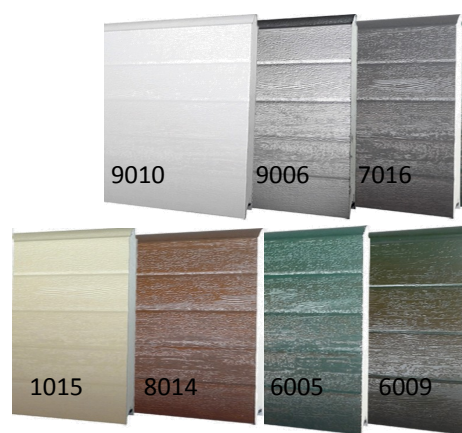

**Cores Standard disponíveis:
Textura LISO**



**Cores Standard disponíveis:
Textura SUPER LISO**



Pintura disponível em qualquer cor RAL ou por afinação de cor.

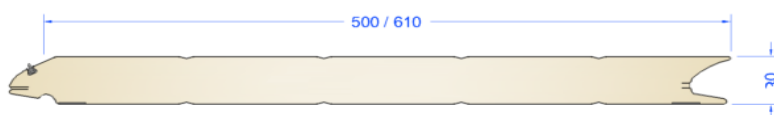



Sistema de segurança:

Tipos de padieiras industriais:

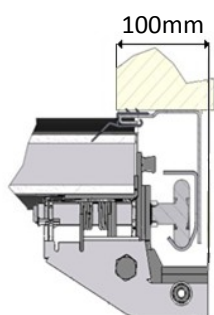

Umbreira mínima necessária de 100 mm.

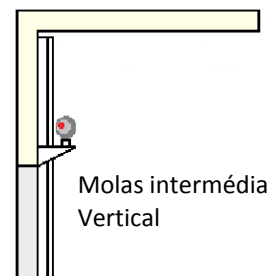
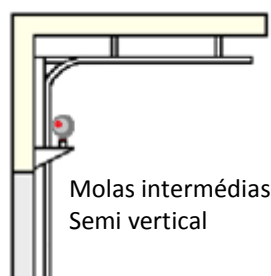
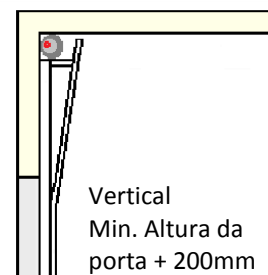
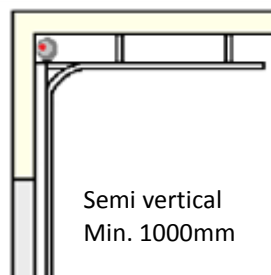
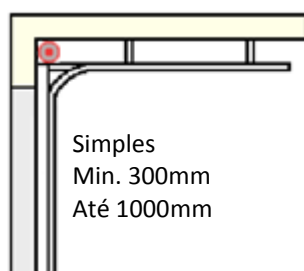



QUALIDADE NO TRABALHO...

Características da porta seccionada modelo IND plus:

- > Painel com 40mm monocasco, enchimento com poliuretano sem C.F.C.;
- > Painel com parede dupla e reforço interior, com sistema anti-esmagamento de dedos;
- > Imitação madeira lacada;
- > Perfis em alumínio lacados;
- > Suportes do cabo de aço em alumínio;
- > Calhas galvanizadas com 2mm;
- > Sistema de anti-rutura de molas, DIN EN 12804;
- > Acessórios lacados em RAL 9010;
- > Vedante inferior e superior em EPDM;
- > Trinco interior;
- > Medidas standard / por medida;
- > Cavaletes largos metálicos;
- > Reforços;
- > Sistema mecânico reforçado;
- > Sistema de segurança Pára-quedas;
- > Certificação CE (EN13241-1:2003).

**Cores Standard disponíveis:
Textura VETEADO**

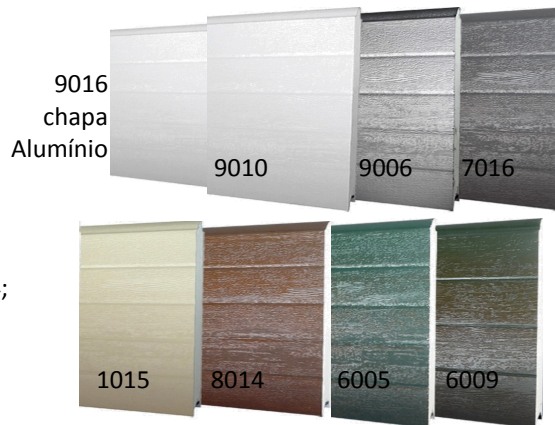

**Cores Standard disponíveis:
Textura SUPER LISO**



Pintura disponível em qualquer cor RAL ou por afinção de cor.

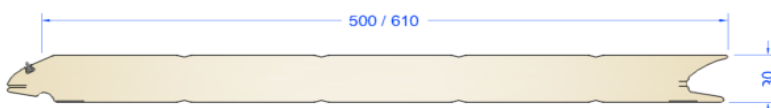



Sistema de segurança:

Tipos de padieiras industriais:

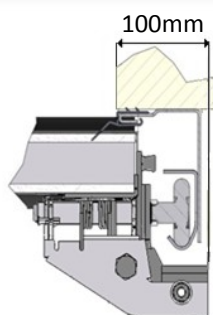

Umbreira mínima necessária de 100 mm.

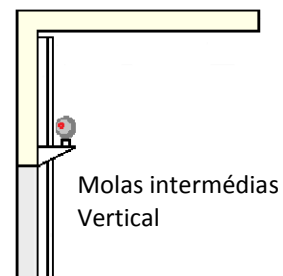
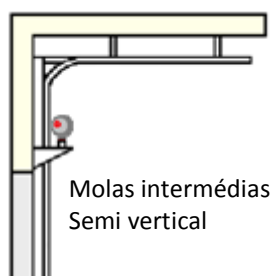
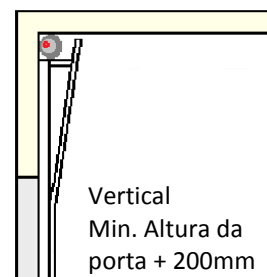
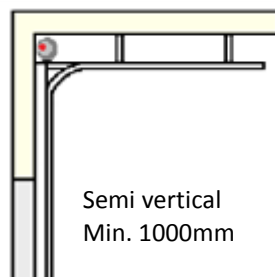
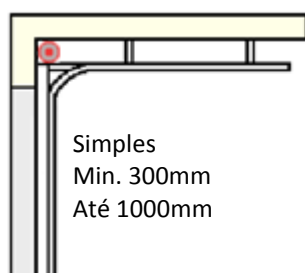

Grades de segurança modelo ROL

Tipos de lamina:



Lâmina curva 75 mm



Lâmina plana 110 mm



Lâmina microperfurada

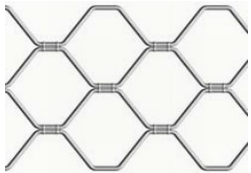

Varão 8 mm Losangos

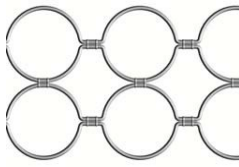

Varão 8 mm Aros

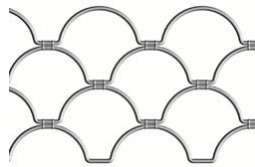

Varão 8 mm Concha



Lâmina Alumínio
Plana 100 mm



Lâmina Alumínio
Microperfurada 100 mm



Lâmina Alumínio
Térmica 77 mm



Pintura disponível em qualquer cor RAL.

Tipos de tampais:

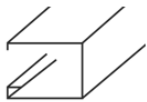

Quadrada

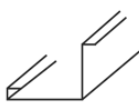

em "L"

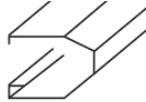

Concava

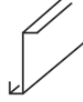

Plana

Tipos de automatismos:



Motor central



Motor lateral

ROL

SEGURANÇA E RIGOR...





OP
DOK

**DESCARGA
SIMPLIFICADA...**

Sistemas industriais de descarga modelo OP DOK



Cais de carga



Foles de encosto

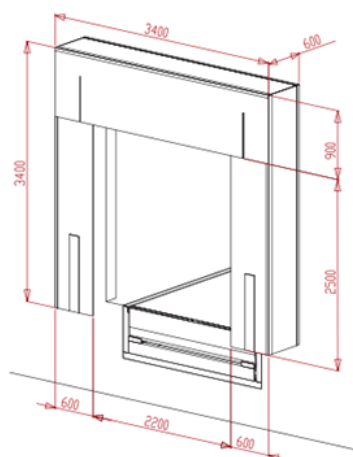

Guias de pavimento



Borrachas de proteção



Quadro de comandos

Porta rápida em PVC modelo OP FAST

Porta Rápida de enrolar modelo Easy Fast



- > Dimensões máximas: largura: 5m Altura: 5m
- Escova de proteção às guias laterais
- Numero de voltas à saída: 160/min
- Tempo de abertura: 1 m/s
- Alimentação trifásico 230/400V
- Potência: 0,55 KW
- Índice de Proteção: IP54
- Travão elétrico.

Porta Rápida de enrolar modelo Strong Fast



- > Dimensões máximas: largura: 6m Altura: 6m
- Borracha de proteção nas bordas da tampa
- Numero de voltas à saída: 115/min
- Tempo de abertura: 1 m/s
- Alimentação trifásico 230/400V
- Potência: 0,65 KW
- Índice de Proteção: IP54
- Travão elétrico.

Especificações Gerais:

Estrutura

- > Estrutura sólida auto-suportada com 2mm de espessura;
- > Acabamento lacado ou galvanizado de acordo com as cores em catálogo;
- > Veio em aço.

Tela

- > Tela de 900 g/m² de poliéster coberto por PVC
- > Resistente e reabilitável em todas as aplicações;
- > Comportamento face a fogo: dificilmente inflama com combustíveis e não propaga o fogo;
- > Tudo horizontal para reforçar a resistência à pressão dos ventos.

Segurança

- > Focelulas incorporadas nas guias laterais.

Quadro control

- > Alimentação trifásica 400V com configuração digital de fins de curso;
- > Nível de proteção IP54 e IP65;
- > Programação digital;
- > Três botões industriais (Abrir / Parar / Fechar)
- > Modos de funcionamento: abertura e fecho com homem presente / abertura automática e fecho com homem presente / abertura automática e fecho com temporizador (de 1 a 240 segundos).

Extras:

- > Opção de tela com janelas;
 - > Opção de banda de segurança, esta evita que danifique a tela para não permitir o fecho se detetar um obstáculo
- no caso de embate de pessoas ou objetos contra a tela;
- > Opção de campo magnético, radar, receptor + emissor, fotocelulas e botoneira.



OP FAST

**MAIS RAPIDA DO QUE A
PRÓPRIA SOMBRA...**

OP
GLASS

MAIS ILUMINAÇÃO...



Porta seccionada industrial envidraçada modelo OP GLASS

Esta porta poderá ter múltiplas combinações de painel em alumínio envidraçado com painel sandwich, conforme o nível de iluminação que seja desejado para o local em questão.



Painel em alumínio envidraçado com espessura de 40 mm e acrílico de 4 mm.

Pintura disponível em qualquer cor RAL ou por afinção de cor.



Plano Parque Empresarial BC108
Rua de Batel
4485-253
Guilhabreu - Portugal

www.opertac.com
info@opertac.com
tel. 00351 926 239 623 /
00351 220 933 194
Skype: opertac-commercial

